

ALYSIUM

A+ Product Overview



» The A+ USB3 cable you provided me, outperformed (in an application relevant way) every cable we have ever used. I'm impressed. *R. Wiley (3SAE)*

» Alysium cables have performed far beyond our expectations, providing outstanding reliability in a noisy environment where other cables failed. *Justen Hyde (Emergent Design Ltd)*

Our A+ Family includes
Rj45, USB3 & BRJE

Discover more: www.alysium.com



USB 3.1



Features

- › Market leading Industrial Die-Cast Design.
- › 360° EMI Protection.
- › USB A, B and Type C with unique screwlock bracket (design protected).
- › Additional vertical screwlock accessories available for USB A and Type C.
- › 100% tested in Production.
- › Available from Stock (GER).
- › Compliant to the U3V(+) Standard.

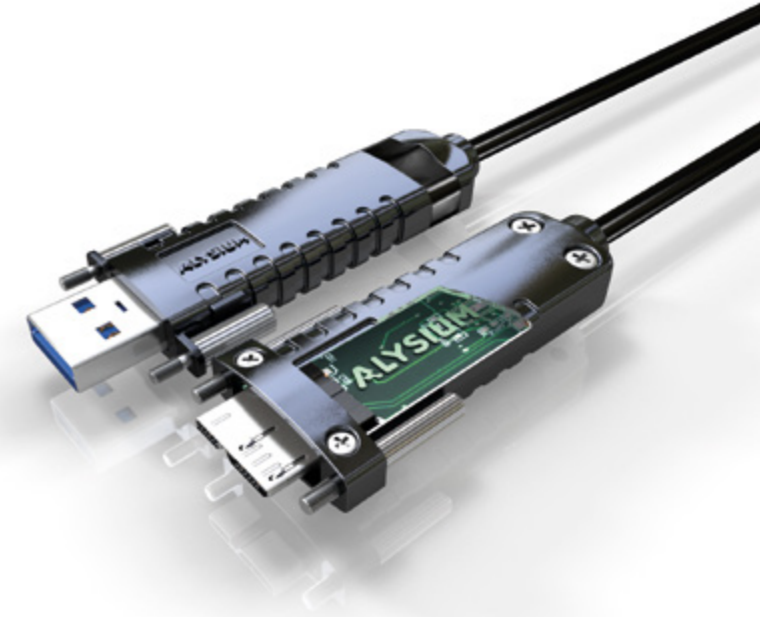

A+ Products

Interface: A+ USB3.1 Gen1 (copper)

| Part Number(s) | Product Description | 1 M | 2M | 3M | 4M | 5M | 8M | 10M |
|----------------|--|-----|----|----|----|-----|----|-----|
| A74-9968[X] | A+ USB A (screwlock bracket) // A+ USB micro B (screwlock) | X | X | X | | X | | |
| A74-0147[X] | A+ USB A (screwlock bracket) // A+ USB micro B (screwlock) Ext. Length Passiv | | | | | (X) | X | X* |
| A74-8823[X] | A+ USB A (screwlock bracket) // A+ USB micro B (screwlock bracket) High Flex (copper) | X | X | X | X | X* | | |
| A74-6659[X] | A+ USB A (screwlock bracket) // A+ USB B (screwlock bracket) | X | X | X | | X | | |
| A74-9857[X] | A+ USB A (screwlock bracket) // A+ USB Type C (screwlock bracket) | X | X | X | | X | | |

Interface: A+ USB3.1 Gen1 (active optical)

| Part Number(s) | Product Description | 5M | 10M | 15M | 20M | 25M | 50M |
|----------------|--|----|-----|-----|-----|-----|-----|
| A70-8403[X] | A+ USB A (screwlock bracket) // A+ USB micro B (screwlock) AOC Highflex / Torsional | X | X | X | X | X | X |

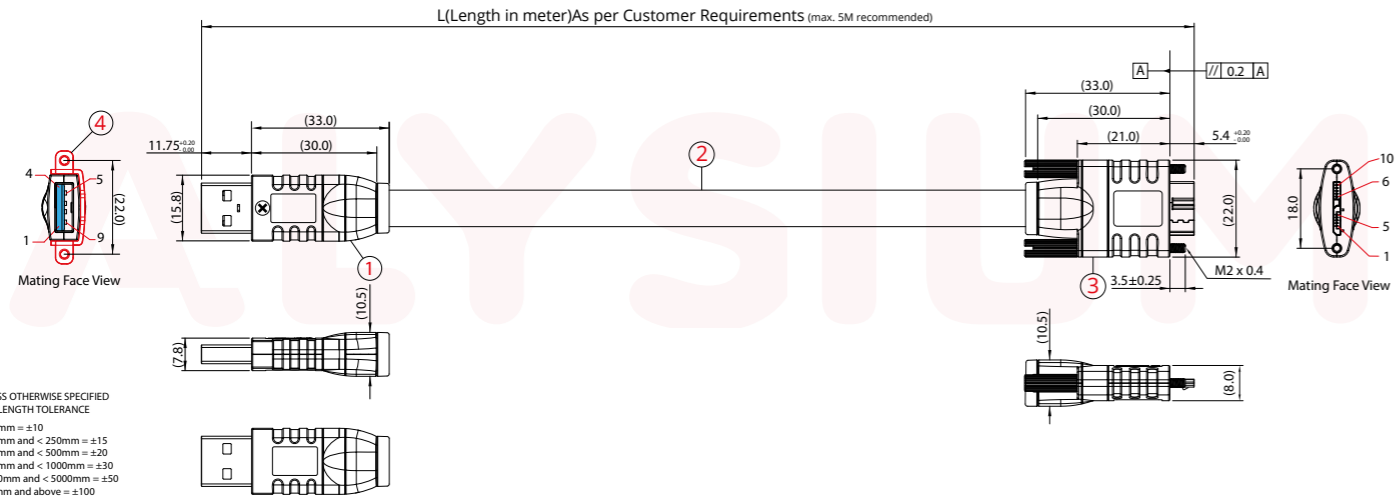

UNLESS OTHERWISE SPECIFIED
 ASSY LENGTH TOLERANCE
 < 150mm = ±10
 ≥ 150mm and < 250mm = ±15
 ≥ 250mm and < 500mm = ±20
 ≥ 500mm and < 1000mm = ±30
 ≥ 1000mm and < 5000mm = ±50
 5000mm and above = ±100

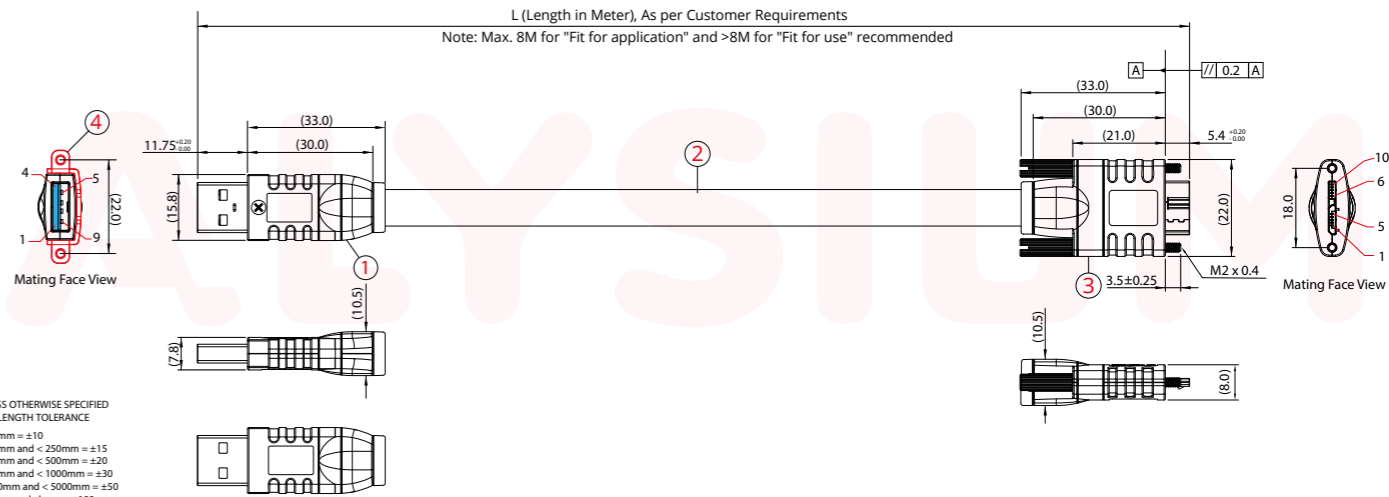

UNLESS OTHERWISE SPECIFIED
 ASSY LENGTH TOLERANCE
 < 150mm = ±10
 ≥ 150mm and < 250mm = ±15
 ≥ 250mm and < 500mm = ±20
 ≥ 500mm and < 1000mm = ±30
 ≥ 1000mm and < 5000mm = ±50
 5000mm and above = ±100

RoHS COMPLIANT

This document is the property of Alysium-Tech. It must not be copied or otherwise disclosed without prior written consent

| Item | Description |
|------|--|
| 1 | A+ USB A 3.0 (OD5.8 Die Cast Threaded) Die Cast Shell incl. M2.6x2.5 screw (to be disposed, when bracket is applied) |
| 2 | A86-4730(T), [OD=6.2mm] <BLK> E357566-ALY-T UL2725 2STP(#26x2C)+STP#28+2C#22 |
| 3 | A+ USB MicB 3.0 sl (OD5.8 Die Cast) Die Cast Shell |
| 4 | USB A 3.0 (Die Cast) sl Bracket (Refer to Accessories Details) |

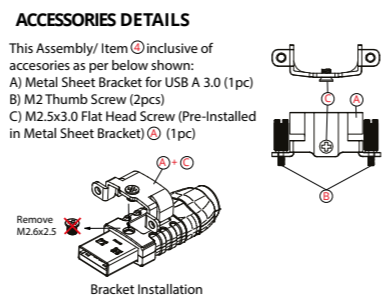
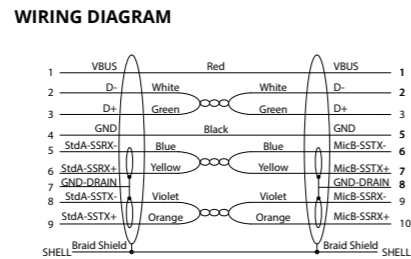

RoHS COMPLIANT

This document is the property of Alysium-Tech. It must not be copied or otherwise disclosed without prior written consent

| Item | Description |
|------|--|
| 1 | A+ USB A 3.0 (OD8.0 Die Cast Threaded) Die Cast Shell incl. M2.6x2.5 screw (to be disposed, when bracket is applied) |
| 2 | MCD-USB-213(T), [OD = 8.0mm] <BLACK> UL 20276, STP#23, 1xUSB2 UTP#24, 2C#20 (Min. Static Bending Radius = 125mm) |
| 3 | A+ USB MicB 3.0 sl (OD8.0 Die Cast) Die Cast Shell |
| 4 | USB A 3.0 (Die Cast) sl Bracket (Refer to Accessories Details) |

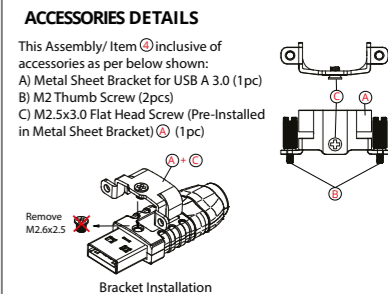
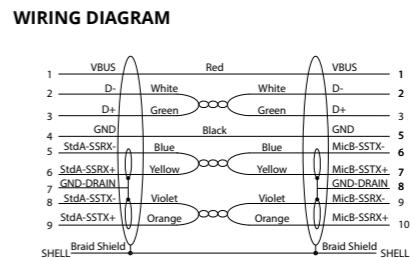

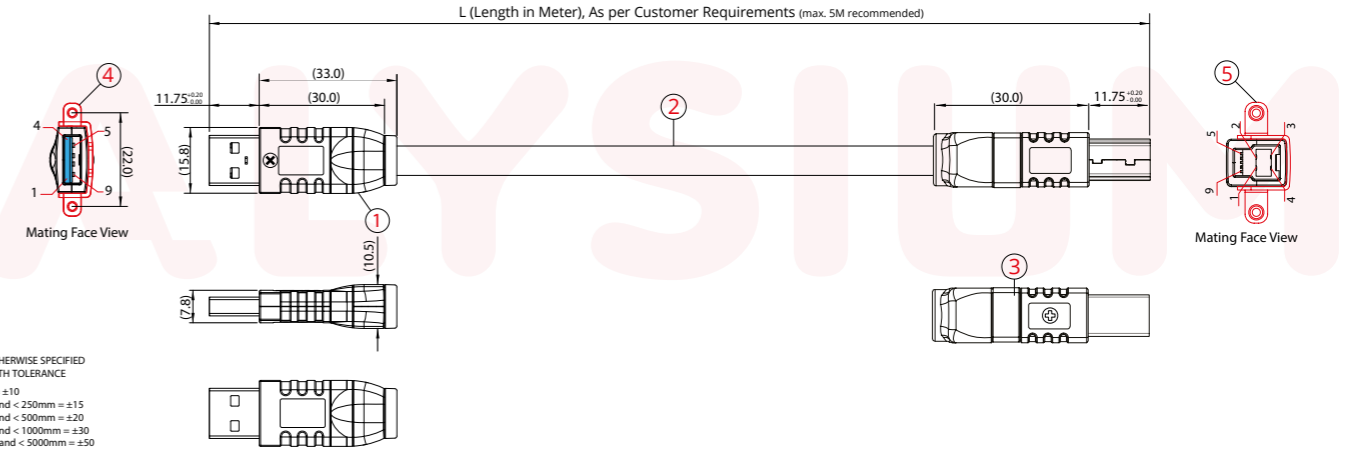
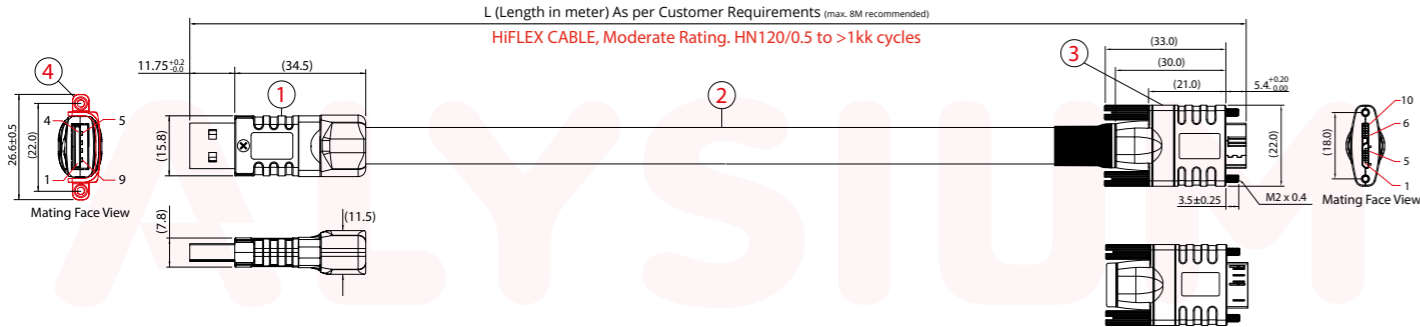

ALL UNITS IN MM
 UNLESS OTHERWISE SPECIFIED
 ASSY LENGTH TOLERANCE
 < 150mm = ±10
 ≥ 150mm and < 250mm = ±15
 ≥ 250mm and < 500mm = ±20
 ≥ 500mm and < 1000mm = ±30
 ≥ 1000mm and < 5000mm = ±50
 5000mm and above = ±100

UNLESS OTHERWISE SPECIFIED
 ASSY LENGTH TOLERANCE
 < 150mm = ±10
 ≥ 150mm and < 250mm = ±15
 ≥ 250mm and < 500mm = ±20
 ≥ 500mm and < 1000mm = ±30
 ≥ 1000mm and < 5000mm = ±50
 5000mm and above = ±100

RoHS COMPLIANT

This document is the property of Alysium-Tech. It must not be copied or otherwise disclosed without prior written consent

BILL OF MATERIALS

| Item | Description |
|----------------------------|--|
| 1 | A+ USB A 3.0 (OD9.45 DCT) |
| 2 | A87-3502 [OD=9.45mm] <VIOLET> |
| 3 | 2xSuperSpeed Parallel Pair #26, 1xUSB2 UTP#28, 2C#28 |
| 4 | A+ USB MicB 3.0 sl (OD7.3 DC) |
| Covered with Shrink Tubing | |
| 4 | USB A (DC) Bracket (Refer to Accessories Details) |

TEST SPECIFICATION

Electrical Test (Continuity, Insulation Resistance, Conductance Test)
 For Assembly Length < 20m
 1) Voltage = 300VDC,
 2) Insulation Resistance = 20MΩ
 3) Conductance = 3Ω

For Assembly Length ≥ 20m
 1) Voltage = 500VDC,
 2) Insulation Resistance = 20MΩ
 3) Conductance = 5Ω

WIRING DIAGRAM

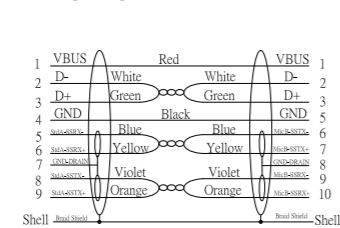

ACCESSORIES DETAILS

This Assembly/ Item inclusive of accessories as shown below:
 A) Metal Sheet Bracket for USB A 3.0 (1pc)
 B) M2 Thumb Screw (2pcs)
 C) M2.5x3.0 Flat Head Screw (Pre-Installed in Metal Sheet Bracket) (1pc)

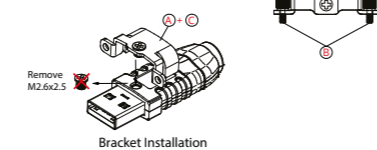

RoHS COMPLIANT

This document is the property of Alysium-Tech. It must not be copied or otherwise disclosed without prior written consent

BILL OF MATERIALS

| Item | Description |
|------|--|
| 1 | A+ USB A 3.0 (OD5.8 Die Cast Threaded) Die Cast Shell |
| 2 | A86-4730(T), [OD=6.2mm] <BLK> |
| 3 | E357566-ALY UL2725 2STP#26 + 1P#28 + 2C#22 |
| 4 | A+ USB B 3.0 (OD5.8 Die Cast) Die Cast Shell |
| 4 | USB A 3.0 (Die Cast) sl Bracket (Refer to Accessories Details) |
| 5 | USB B 3.0 (Die Cast) sl Bracket (Refer to Accessories Details) |

WIRING DIAGRAM

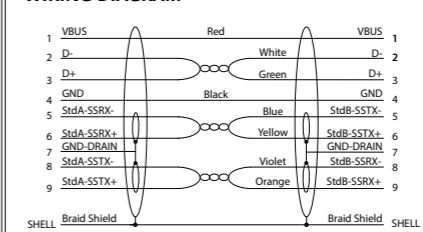

ACCESSORIES DETAILS

This Assembly/ Item inclusive of accessories as per below shown:
 A) Metal Sheet Bracket for USB A 3.0 (1pcs) & USB B 3.0 (1pcs)
 B) M2 Thumb Screw (2pcs)
 C) M2.6x3.0 Flat Head Screw (Pre-Installed in Metal Sheet Bracket) (1pc)

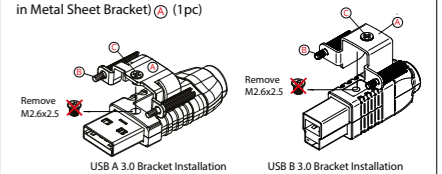



Accessory

- › USB A Vertical Screwlocking Hood

Part No: USB **A** Vsl PVC Brkt Kit

- › USB Type C Vertical Screwlocking Hood

Part No: USB **C** Vsl PVC Brkt Kit

DRAWING REF: **USB A Vsl PVC Brkt Kit**
 DRAWING REF: USB A Vsl (PVC) Bracket Kit
 (Chua 180327) Refresh Specification

DRAWING REF: **USB C Vsl PVC Brkt Kit**
 DRAWING REF: A+ USB C Vertical Screw Lock Bracket
 REVISION: 00 (Chua 180924) Initial Issue

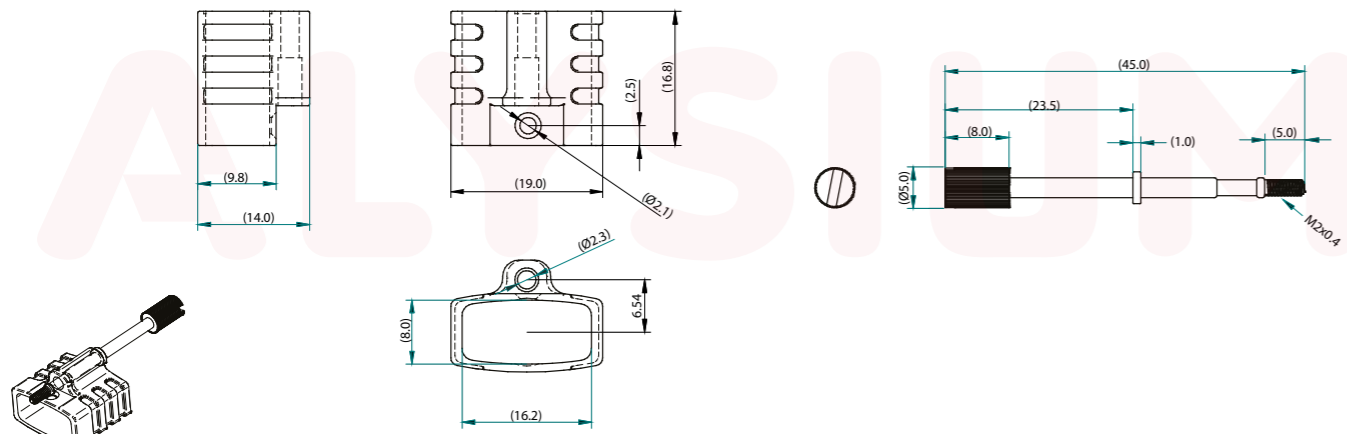

3D View

This document is the property of Alysium-Tech. It must not be copied or otherwise disclosed without prior written consent

RoHS COMPLIANT

| BILL OF MATERIALS | | Note : | PACKAGING DETAIL |
|-------------------|---|--|------------------|
| Item | Description | | |
| 1 | USB A Vsl Bracket (PVC) Colour = PANTONE 1797 C/U CMYK 0/100/95/5 RGB 220/7/20 | This detachable PVC Hood can be matched with 1) USB A 3.0 (OD5.8 DCT) 2) USB A 3.0 (OD7.3 DCT) 3) USB A AOC (OD3.6 DCT) | |
| 2 | Thumbscrew M2, Material = Steel, Nickel Plate | | |
| 3 | M2.5x3.0 Flat Head Screw | | |
| 4 | Heat Seal PE Bag | | |
| 5 | Small Heat Seal PE Bag (60 x 80mm) | | |

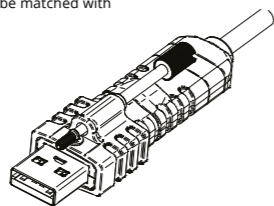

E.g : Installed on USB A AOC (OD3.6 DCT)

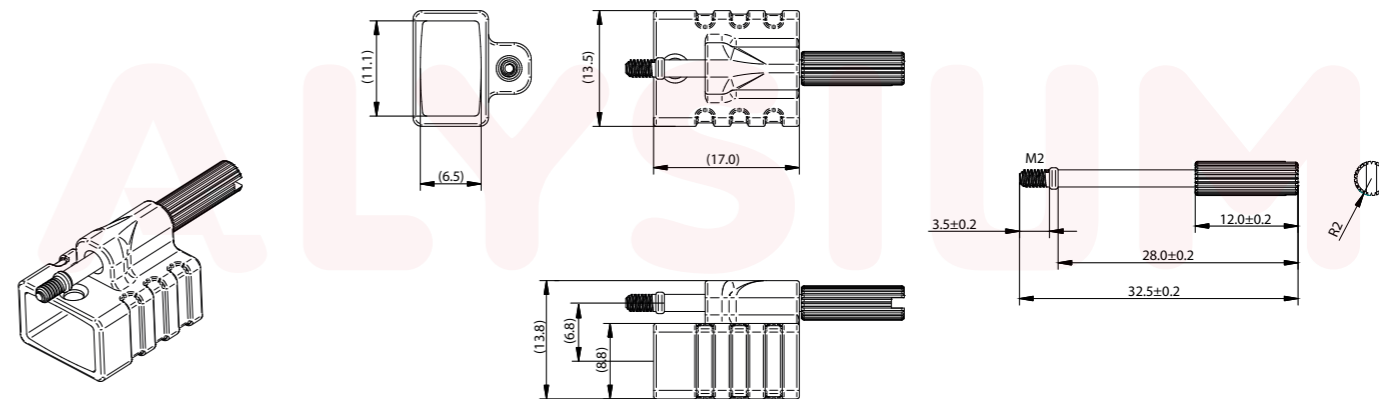

3D View

This document is the property of Alysium-Tech. It must not be copied or otherwise disclosed without prior written consent

RoHS COMPLIANT

| BILL OF MATERIALS | | Note : | PACKAGING DETAIL |
|-------------------|---|--|------------------|
| Item | Description | | |
| 1 | USB A Vsl Bracket (PVC) Colour = PANTONE 1797 C/U CMYK 0/100/95/5 RGB 220/7/20 | This detachable PVC Hood can be matched with 1) USB C (OD6.2 DCT) | |
| 2 | Thumbscrew M2, Material = Steel, Nickel Plate | | |
| 3 | M2.6x3.0 Flat Head Screw | | |
| 4 | Heat Seal PE Bag | | |
| 5 | Small Heat Seal PE Bag (60 x 80mm) | | |

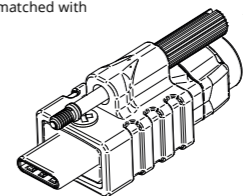

E.g : Installed on USB C (OD6.2 DCT)

RJ45



Features

- › Market leading Industrial Die-Cast Design.
- › 360° EMI Protection.
- › Unique Screw Locking bracket design - horizontal/vertical locking with one Assembly (design protected).
- › Plug length (13,11 and 9mm) according to the GigE Vision Standard with one assembly – (design protected).
- › 100% tested in production.
- › 10G CAT6A.
- › Torsional & C-Track tested (min. 1kk cycles).
- › Available from stock (GER).
- › Available Length: 1M, 2M, 3M, 5M, 10M, 15M, 20M, 25M

A+ Products

Interface: A+ Rj45

| Part Number(s) | Product Description | 1M | 2M | 3M | 5M | 10M | 15M | 20M | 25M |
|----------------|--|----|----|----|----|-----|-----|-----|-----|
| A72-1738[X] | A+ RJ45 // A+ R45 // CAT6A 10G // screwlock + Plug lengths accesspries | X | X | X | X | X | X | X | X |

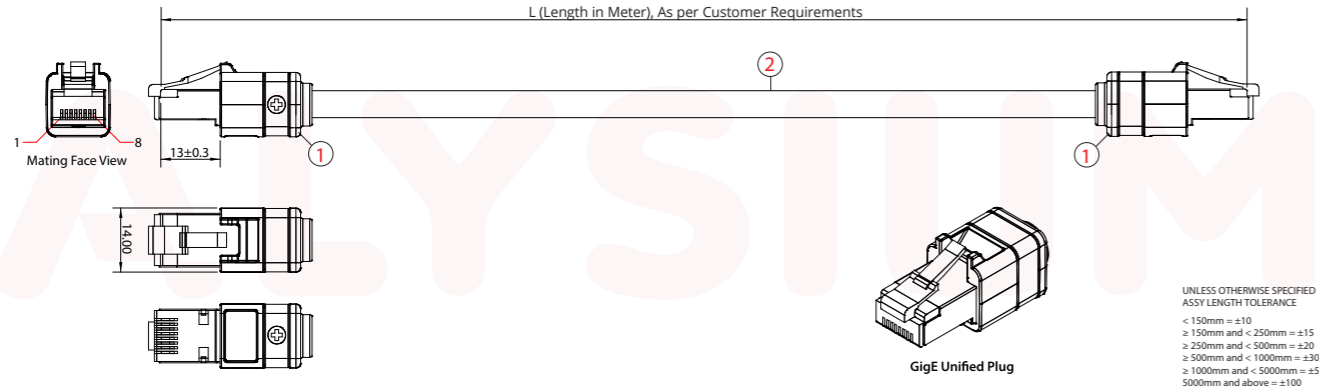

RoHS COMPLIANT

This document is the property of Alysium-Tech. It must not be copied or otherwise disclosed without prior written consent



BILL OF MATERIALS

| Item | Description |
|------|--|
| 1. | A+ RJ45 Unified Plug 8P8C Diecast Metal Shell |
| 2. | A07-0528, [OD=5.89mm] <BLK> |
| 3. | Halogen Free CAT7 4P x #26, Dual Shielded with LSZH TPU Jacket |
| 3 | Accessories (Please refer to Accessories Details): |

TEST SPECIFICATION

Electrical Test (Continuity, Insulation Resistance, Conductance Test)

For Assembly Length < 20m

- 1) Voltage = 300VDC,
- 2) Insulation Resistance = 20MΩ
- 3) Conductance = 3Ω

For Assembly Length ≥ 20m

- 1) Voltage = 500VDC,
- 2) Insulation Resistance = 20MΩ
- 3) Conductance = 5Ω

WIRING DIAGRAM

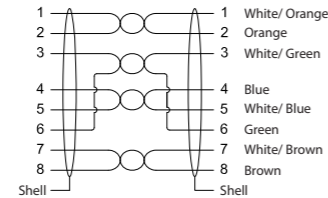

Note: All the Pair Shield connected to B. Shield

ACCESSORIES DETAILS

This Assembly/ Item ① inclusive of accessories as per below shown:
 A) Metal Sheet Bracket (1pc)
 B) M2 Thumb Screw (2pcs)
 C) M2.6 x 2.5mm Flat Head Screw (1pc) (Pre-installed in RJ45 connector)
 D) M2.6 x 5.0mm Flat Head Screw (1pc) (Use for install Metal Housing Bracket) ②, ③
 E) Spacer (Thickness = 2 mm & 4mm) (Each 1pc)

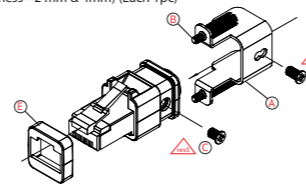

PLUG LENGTH & LOCKING BRACKET CUSTOMIZATION:

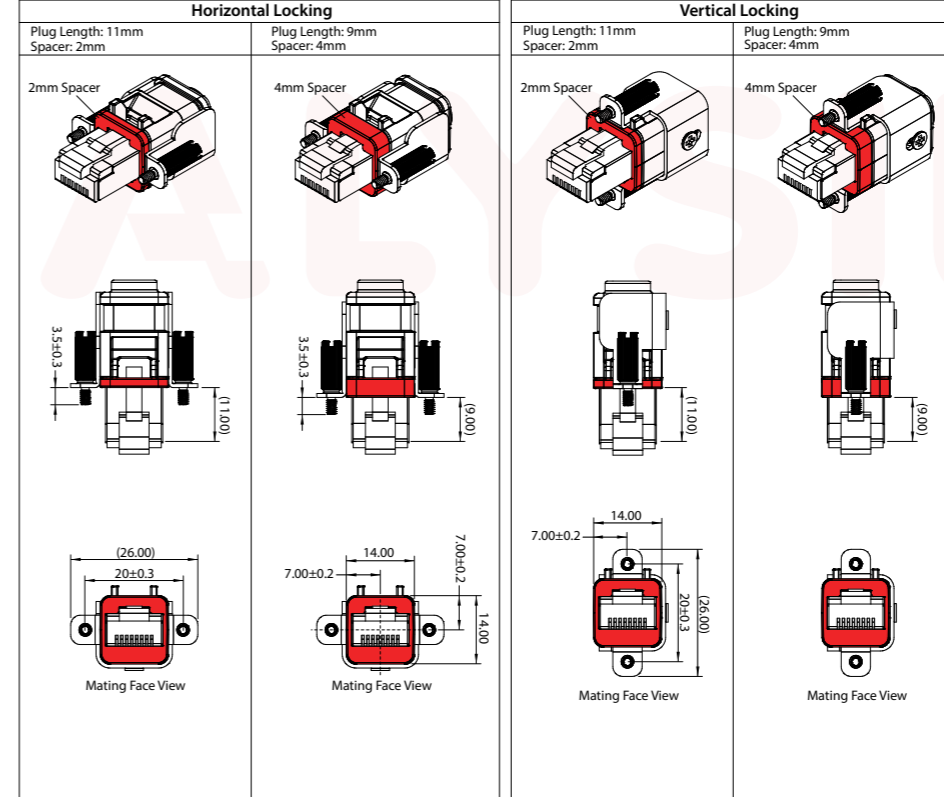

Bracket Installation Guide line

Step 1: Remove rubber ring from the die cast body to reveal the threaded mounting hole

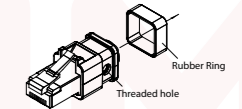

Step 2: Determine the plug length required (9mm or 11mm) and insert the spacer to the plug from the front to depress on the latch tab

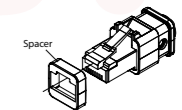

Step 3: After spacer installation, glide the bracket from the back and fasten using M2.6 x 5.0mm screw provided

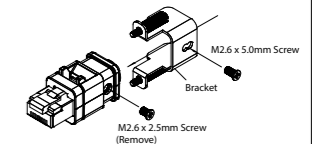

Step 4: Customization/ installation completed
 Same steps apply to horizontal bracket installation

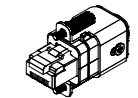

BRJE

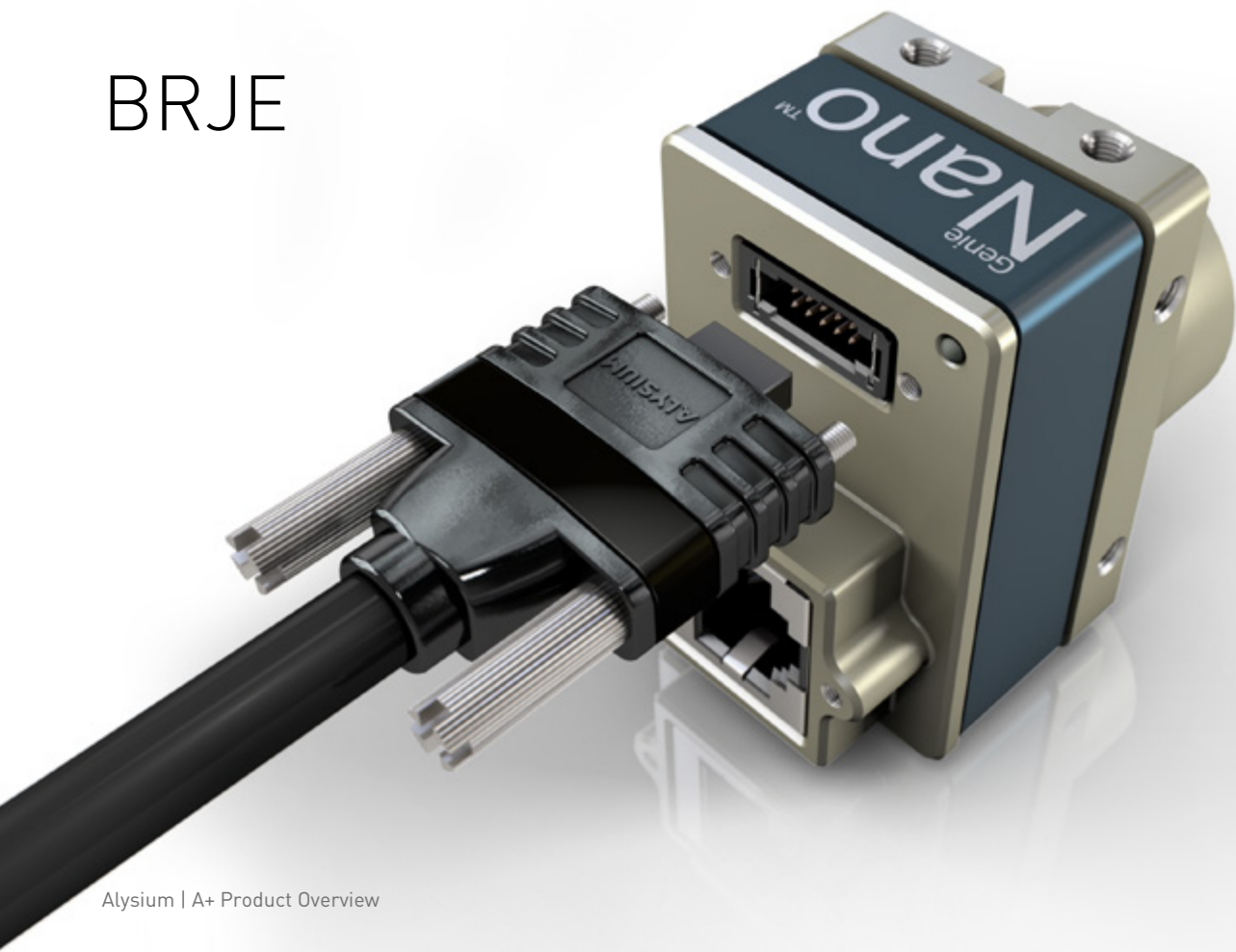

Features

- › Market leading Industrial Die-Cast Design.
- › 360° EMI Protection.
- › Unique Interface design.
- › Space saving.
- › Cost reduction compared to traditional Circular Connectors.
- › Design approved by TELEDYNE DALSA.
- › Available from stock (GER).
- › Available Length: 1M, 2M, 3M, 5M, 10M, 15M, 30M

A+ Products

Interface: A+ BRJE

| Part Number(s) | Product Description | 1M | 2M | 3M | 5M | 10M | 15M | 30M |
|----------------|---------------------|----|----|----|----|-----|-----|-----|
| A65-3210[X] | A+ BRJE // Pigtail | X | X | X | X | X | X | X |

DRAWING REF: **A65-3210**

DRAWING REF: IO Industrial Assembly

| REVISION: | 00 | (WON 161207) | Initial Issue |
|-----------|----|--------------|---------------------|
| | 01 | (WON 170801) | Add Polarization |
| | 02 | (WON 170802) | Change Cable Label |
| | 03 | (WON 170825) | Change Polarization |
| | 04 | (WON 170830) | Wiring Dia. Updates |
| | | | Add Cable Info |

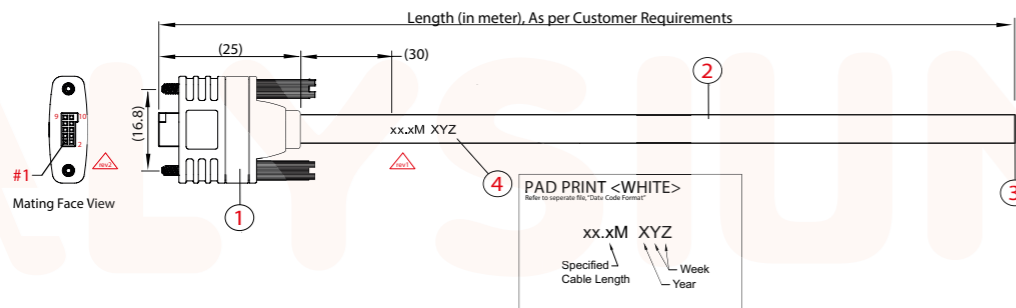

UNLESS OTHERWISE SPECIFIED
 ASSY LENGTH TOLERANCE
 < 150mm = ±10
 150mm and < 250mm = ±15
 250mm and < 500mm = ±20
 500mm and < 1000mm = ±30
 1000mm and < 5000mm = ±50
 5000mm and above = ±100

This document is the property of Alysium-Tech. It must not be copied or otherwise disclosed without prior written consent

RoHS COMPLIANT

BILL OF MATERIALS

| Item | Description |
|------|--|
| 1 | 10P(1.27) DRsl (DCT) Samtech (SFM Series Pitch 0.050" 10P Dual Row) |
| 2 | A11-3069 - UL20276 9C#30 Cable |
| 3 | Processed End - Flat Cut |
| 4 | Cable Label (White Pad Print) |
| 5 | Heat Seal PE Bag |

WIRING DIAGRAM

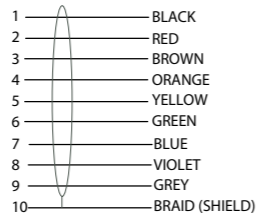

PACKAGING DETAIL

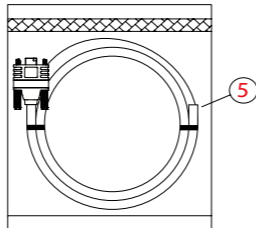

ALYSIUM



Germany

Andernacher Strasse 31b
90411 Nuremberg

T +49 911 93 78 78 0

USA

101 Montgomery Street, Suite 1900
San Francisco, CA 94104

T +1 415 248 7807

Malaysia

Oasis Square
Ara Damansara PJU 1A 47301
Petaling Jaya

T +603 7832 6889

sales@alysium.com

www.alysium.com

